

2090
Max Höjd 2390

Glasöppning/Tät

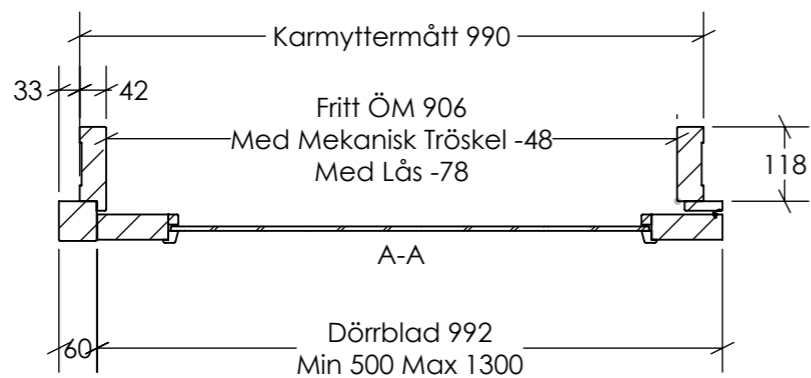

Karmyttermått 990

33 42

Fritt ÖM 906
Med Mekanisk Tröskel -48
Med Lås -78

118

A-A

Dörrblad 992
Min 500 Max 1300

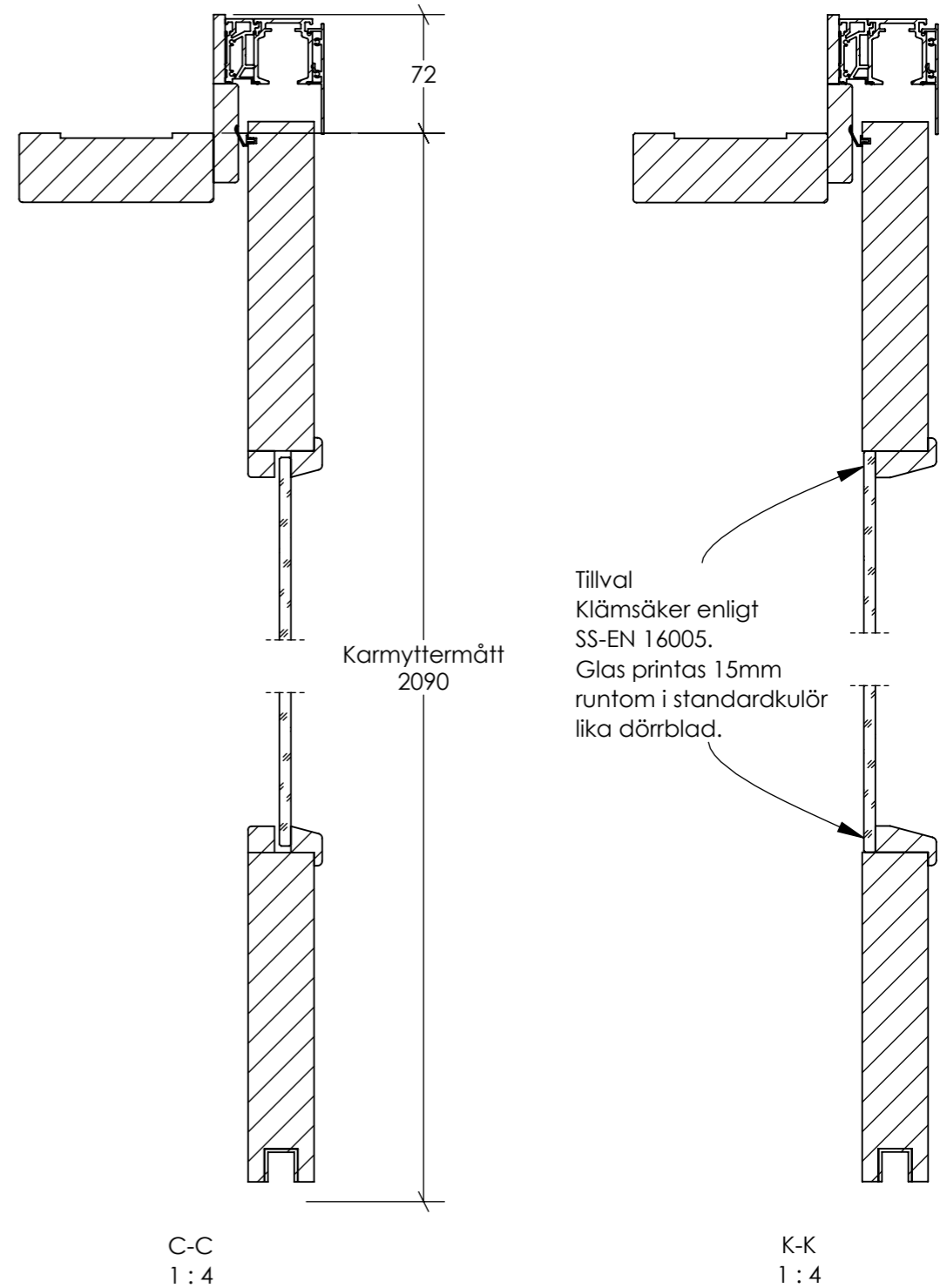

72

Karmyttermått
2090

Tillval
Klämsäker enligt
SS-EN 16005.
Glas printas 15mm
runtom i standardkulör
lika dörrblad.

C-C
1 : 4

K-K
1 : 4

Ritad av EI		Filnamn USKJ 1	Datum 2024-02-29	Skala 1:12
SSC Klingan		Titel Utanpåliggande skjutdörr Höger		
		Träkarm M10x21		
Ritningsnummer A3-01			BET A	Blad 1/3
Lagergatan 1E, 931 36 Skellefteå, Tel: 0910-71 44 80, Fax: 0910-71 44 85				

EXEMPEL VID ELFYLLNING PÅ ANSLAGSSIDA

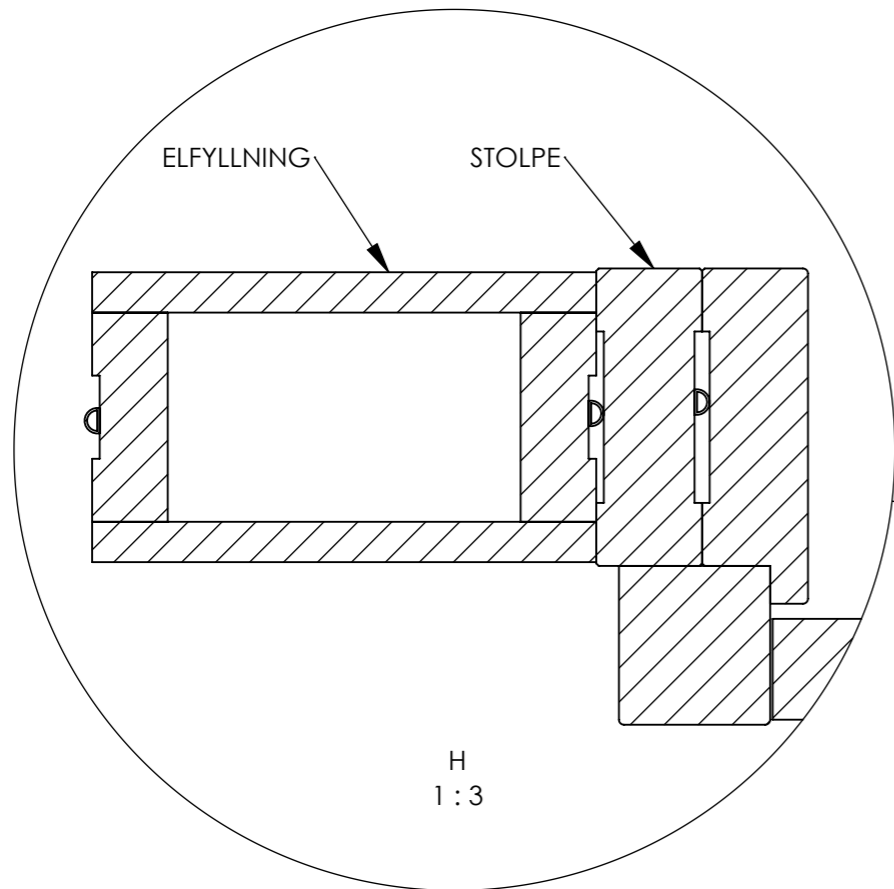

H
1 : 3

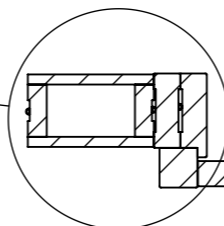
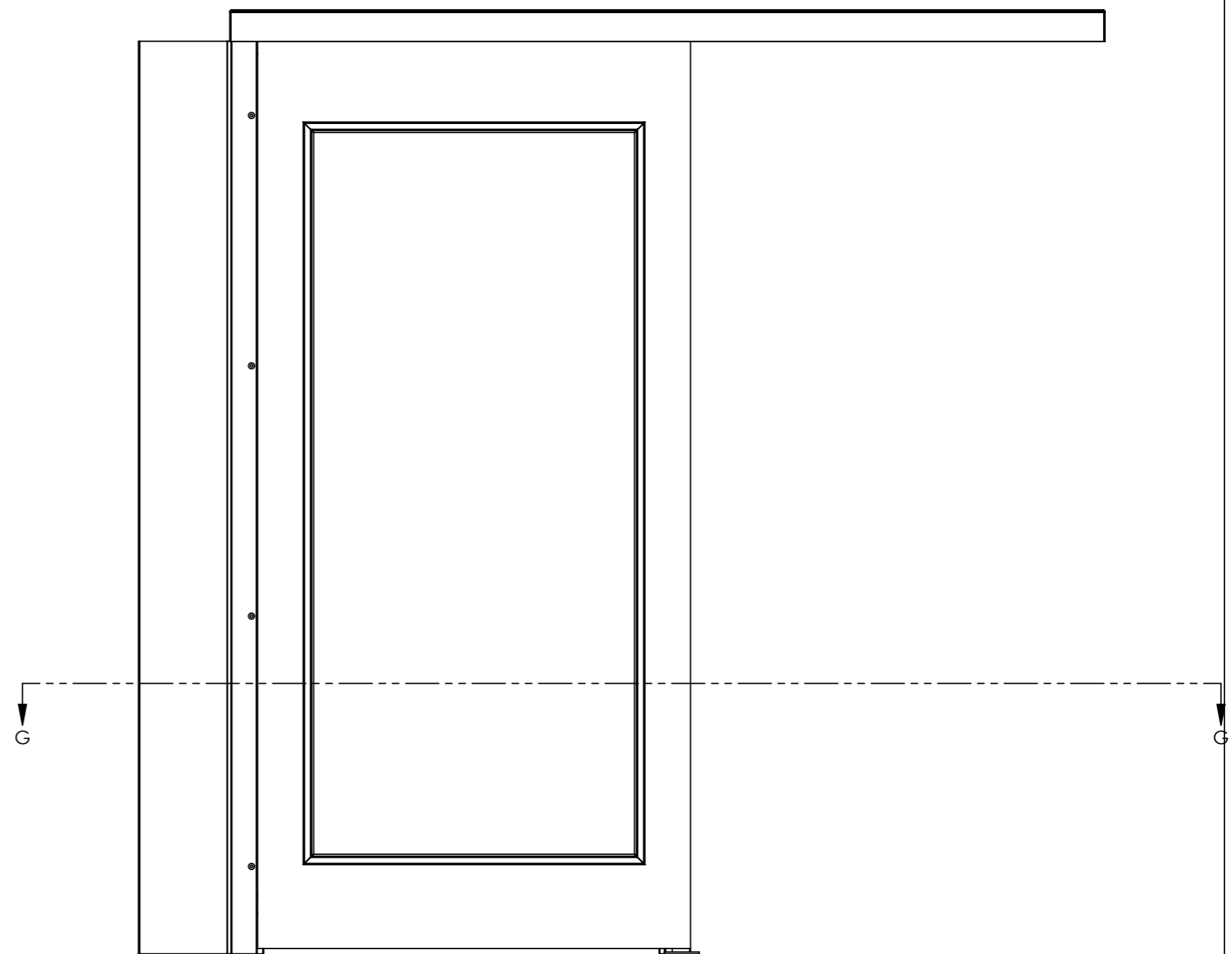

G-G
1 : 12

Ritad av EI		Filnamn USKJ 1	Datum 2024-02-29	Skala 1:20
SSC Klingan		Titel Utanpåliggande skjutdörr Höger Träkarm		
Lagergatan 1E, 931 36 Skellefteå, Tel: 0910-71 44 80, Fax: 0910-71 44 85		Ritningsnummer A3-01	BET A	Blad 2/3

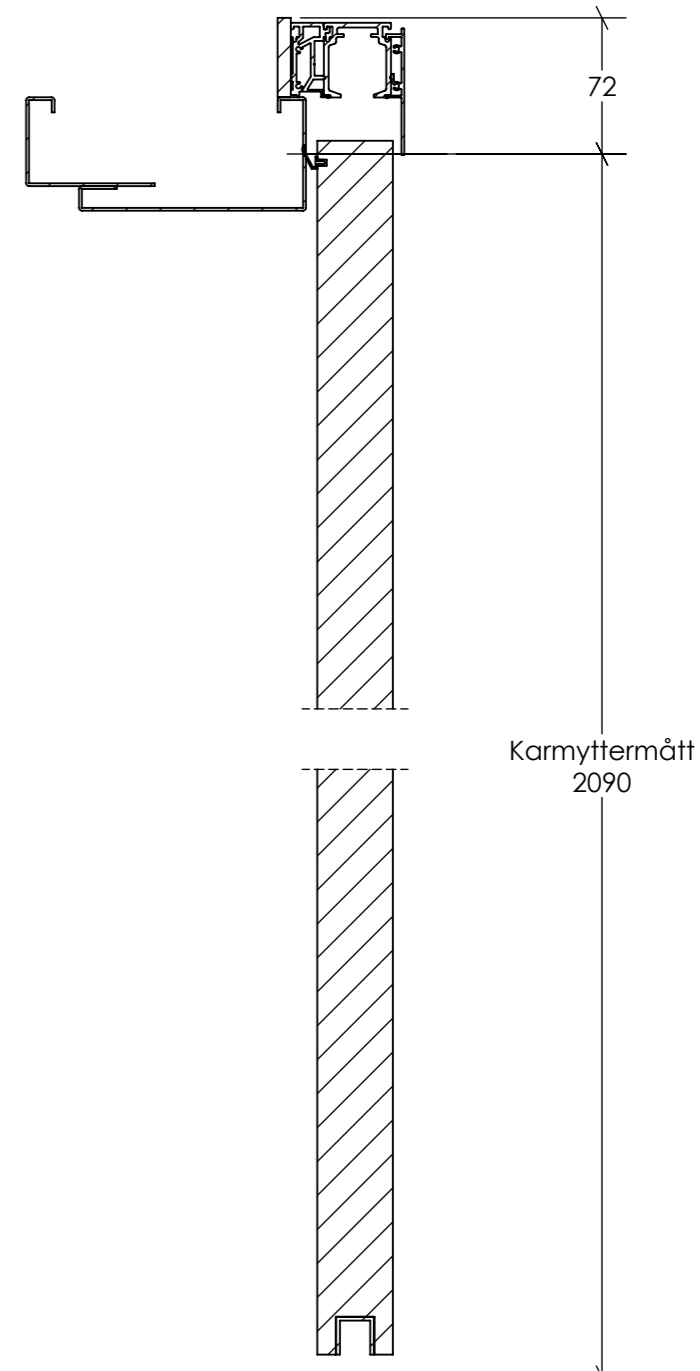
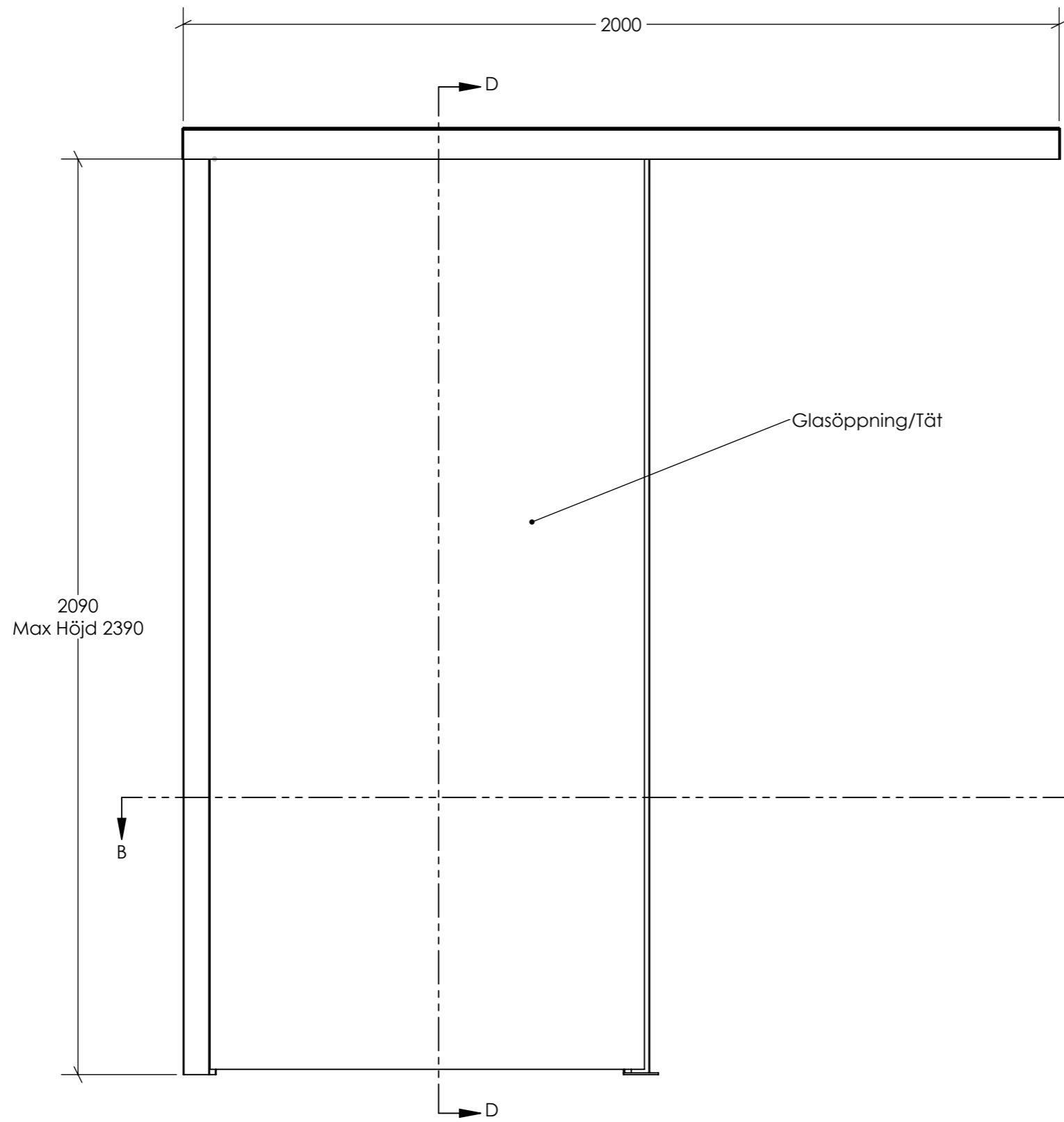

D-D
1 : 4

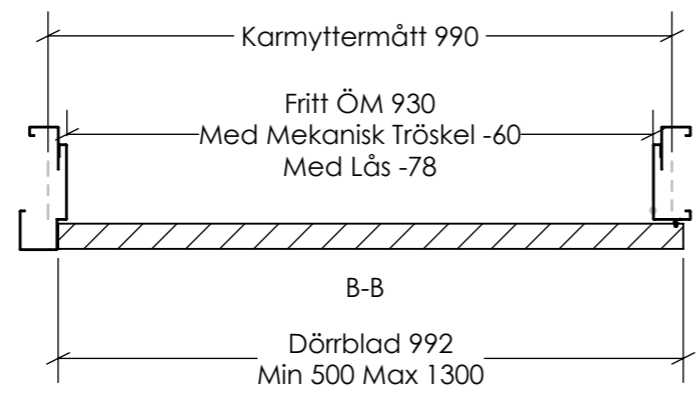

Ritad av EI		Filnamn USKJ 1	Datum 2024-03-07	Skala 1:12
SSC Klingan		Titel Utanpåliggande Skjutdörr Stålkarm, foderbildande 2 sidor		
		Ritningsnummer A3-01	BET A	Blad 3/3
Lagergatan 1E, 931 36 Skellefteå, Tel: 0910-71 44 80, Fax: 0910-71 44 85				